

C/N:HLK

P/C:HLK-402

P/N:HLK-402

CUSTOMER REV:

APPROVED BY:

REV:

DESCRIPTION

DATE

SIGNATURE

REVISIONS



1.6
The remaining

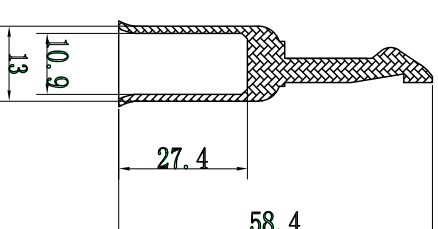
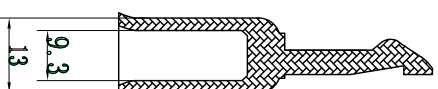
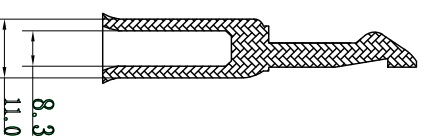
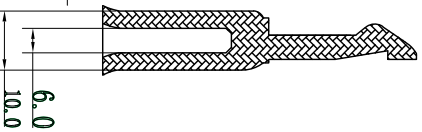
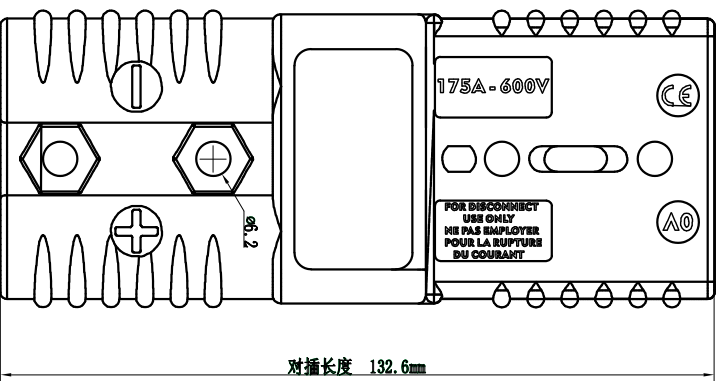
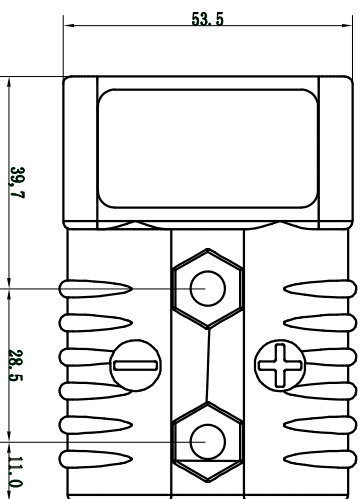
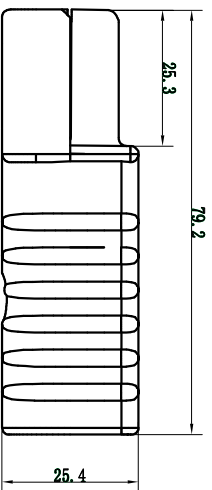
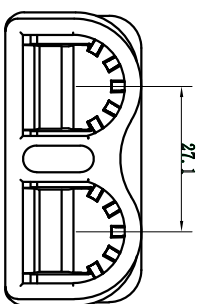

Standard Equipment

#6

#4

#2

#1/O

SPECIFICATION

Rated Operating Voltage	600V
Rated Current	175A
Peak Current	210A
Insulation Resistance	500MΩ/600V DC
Withstand Voltage/AC	2500V Power/1500VSignal
Durability	5000 Cycles
IP Rating	Mated:IP23 Unmated:N/A
Salt Spray	5% NaCl, 24H
Flame Class	UL94 V-0 (Meterials)
Operating Temperature	-40c~125c
UV Resistance Grade	N/A
Mating Part No	/
Maximum Cable Range	0D550mm

TERMS OF BUSINESS

MOQ	1PCS
Lead Time	1-2 Weeks
HS Code	8544422100
Warranty	1 Year
Terms of Payment	T/T 100%
Terms of Shipment	EX Works

UNMARED TOLERANCE DEFINATION

0~5	±0.2
5~15	±0.3
15~30	±0.5
30~100	±0.8
100~300	±1.0
300~1000	±1.2

SIGNATURE

ENGINEER BY: Mandy hao

MANAGER BY: John Han

CHECKED BY: David Wang

SEALS BY: Eleven Wang



 HONLIX INC.
 HTTP://WWW.HONLIX.COM

PRODUCT NO:HLK-XXX

DATE: 2024.12.11

UNIT: mm

SHEET: 1 OF 1

H/C: HLK-402

REV. 0

①	HLK-402	HLKHLK-402 175A 2PIN Connector	1PCS
NO.	ITEM	DESCRIPTION	QTY

THE INFORMATION CONTAINED HEREIN IS PROPRIETARY TO HONLIX. ANY USE OR DISCLOSURE OF THIS INFORMATION, EXCEPT FOR THE EXCLUSIVE BENEFIT OF HONLIX IS PROHIBITED.